

# Изотермический контейнер для доставки блюд MALINETTE

## Технические характеристики

По вопросам продаж и поддержки обращайтесь:

Алматы (727)345-47-04  
Ангарск (3955)60-70-56  
Архангельск (8182)63-90-72  
Астрахань (8512)99-46-04  
Барнаул (3852)73-04-60  
Белгород (4722)40-23-64  
Благовещенск (4162)22-76-07  
Брянск (4832)59-03-52  
Владивосток (423)249-28-31  
Владикавказ (8672)28-90-48  
Владимир (4922)49-43-18  
Волгоград (844)278-03-48  
Вологда (8172)26-41-59  
Воронеж (473)204-51-73  
Екатеринбург (343)384-55-89

Иваново (4932)77-34-06  
Ижевск (3412)26-03-58  
Иркутск (395)279-98-46  
Казань (843)206-01-48  
Калининград (4012)72-03-81  
Калуга (4842)92-23-67  
Кемерово (3842)65-04-62  
Киров (8332)68-02-04  
Коломна (4966)23-41-49  
Кострома (4942)77-07-48  
Краснодар (861)203-40-90  
Красноярск (391)204-63-61  
Курск (4712)77-13-04  
Курган (3522)50-90-47  
Липецк (4742)52-20-81

Магнитогорск (3519)55-03-13  
Москва (495)268-04-70  
Мурманск (8152)59-64-93  
Набережные Челны (8552)20-53-41  
Нижегород (831)429-08-12  
Новокузнецк (3843)20-46-81  
Ноябрьск (3496)41-32-12  
Новосибирск (383)227-86-73  
Омск (3812)21-46-40  
Орел (4862)44-53-42  
Оренбург (3532)37-68-04  
Пенза (8412)22-31-16  
Петрозаводск (8142)55-98-37  
Псков (8112)59-10-37  
Пермь (342)205-81-47

Ростов-на-Дону (863)308-18-15  
Рязань (4912)46-61-64  
Самара (846)206-03-16  
Санкт-Петербург (812)309-46-40  
Саратов (845)249-38-78  
Севастополь (8692)22-31-93  
Саранск (8342)22-96-24  
Симферополь (3652)67-13-56  
Смоленск (4812)29-41-54  
Сочи (862)225-72-31  
Ставрополь (8652)20-65-13  
Сургут (3462)77-98-35  
Сыктывкар (8212)25-95-17  
Тамбов (4752)50-40-97  
Тверь (4822)63-31-35

Тольятти (8482)63-91-07  
Томск (3822)98-41-53  
Тула (4872)33-79-87  
Тюмень (3452)66-21-18  
Ульяновск (8422)24-23-59  
Улан-Удэ (3012)59-97-51  
Уфа (347)229-48-12  
Хабаровск (4212)92-98-04  
Чебоксары (8352)28-53-07  
Челябинск (351)202-03-61  
Череповец (8202)49-02-64  
Чита (3022)38-34-83  
Якутск (4112)23-90-97  
Ярославль (4852)69-52-93

Россия +7(495)268-04-70

Казахстан +(727)345-47-04

Беларусь +(375)257-127-884

Узбекистан +998(71)205-18-59

Киргизия +996(312)96-26-47

эл.почта: [mho@nt-rt.ru](mailto:mho@nt-rt.ru) || сайт: <https://melform.nt-rt.ru/>











## Isothermal containers for meals delivery

- Suitable for catering companies and foodservice operators, meals on wheels and hospital catering.
- Featuring four perfectly thermal insulated compartments.
- The 3 compartments with dia. 130mm are designed for holding round pan, and the remaining compartment is designed to transport meal complements or one more pan.
- It allows to carry a meal consisting of three or even four courses with differentiated temperature.
- The food can be contained in stainless steel lunch-pans or pyrex lunch-pans.
- Excellent **stacking** and stability of the pans, also during transport.
- Lightweight container, simple to use and fitted with a very practical handle for lifting and transport.
- It assures proper heat retention, limiting the risk of bacterial proliferation whilst preserving food quality and organoleptic characteristics.
- Thanks to its excellent isothermal characteristics, it keeps meals at optimum storage temperature for a long time.
- The isothermal characteristics comply with current regulations (EC Reg. 852/2004 – HACCP-) and with applicable technical standards (EN12571 and Accord AFNOR AC D40-007).
- Produced with blow moulding technology: the base and the lid have a monolithic structure (no sharp corners, junctions and welds).
- **Fully recyclable** at the end of the operating life.

## MANUFACTURING MATERIALS

<b>Polypropylene</b>	inner and outer walls of the base and of the lid; food contact safe	<b>Polyurethane</b>	insulating material between the walls of the base and of the lid free of CFC and HCFC
<b>Polyamide reinforced with fibreglass</b>	latches		

## CHARACTERISTICS

	<p>The <b>stainless steel</b> round pan are available upon request in two versions, one of which can be used directly over an open flame.</p>		<p>The round <b>pyrex</b> round pans can be used in combination with the hot and chilled eutectic plates, to extend the temperature retention of food.</p>
	<p>The eutectic plates are easy to use:</p> <ul style="list-style-type: none"> <li>• <b>chilled plates:</b> must be frozen to a temperature of <b>-3°C</b>;</li> <li>• <b>hot plates:</b> to be soaked in water with a temperature of <b>+80°C</b> for 30 minutes. The conditioning time of the chilled plates depends on the useful refrigeration power of the refrigerating system used.</li> </ul>		<p>Depending on the combination of the plates, it is possible to transport:</p> <ul style="list-style-type: none"> <li>• all the courses in hot bonding</li> <li>• all the courses in chilled bonding</li> <li>• mixed transport of hot and chilled courses</li> </ul>
	<p>It features a practical and effective fastening system, consisting of two latches made of shockproof material.</p>		<p>Equipped with integrated grip handle.</p>
	<p>The isothermal container ensures temperature retention even when the user is not present when the meal is distributed.</p>		<p>Dishwasher safe.</p>
	<p>Monolithic structure, no sharp corners, junctions and welds.</p>		<p>Insulated with CFC and HCFC-free polyurethane foam.</p>
<p>°C</p>	<p>Guaranteed for use from - <b>30°</b> to <b>+100°C</b>.</p>		

## TECHNICAL SPECIFICATIONS

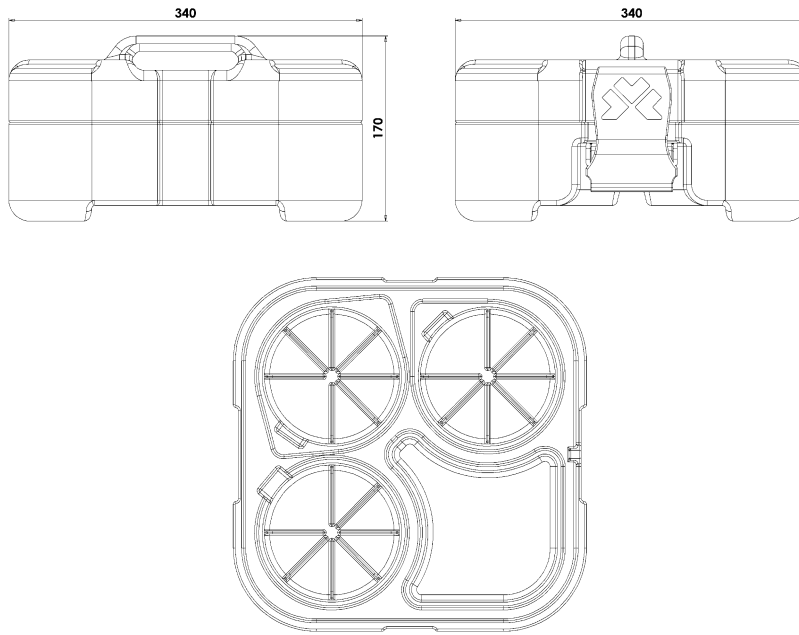

Model	Code	Colour	External dim. (mm)	Capacity l	Weight Kg
Malinette	MAL10006	grey/blue melange			
	MAL10001	blue	340x340xh170		2,2
	MAL10004	red			
Melform lunch-pan	ACA002	stainless steel	dia. 125xh69	0,6	0,56
Hot plate	PEM10001	red	dia. 120xh18		0,15
Chilled plate	PEM10002	blue	dia. 120xh18		0,19

## По вопросам продаж и поддержки обращайтесь:

Алматы (727)345-47-04  
Ангарск (3955)60-70-56  
Архангельск (8182)63-90-72  
Астрахань (8512)99-46-04  
Барнаул (3852)73-04-60  
Белгород (4722)40-23-64  
Благовещенск (4162)22-76-07  
Брянск (4832)59-03-52  
Владивосток (423)249-28-31  
Владикавказ (8672)28-90-48  
Владимир (4922)49-43-18  
Волгоград (844)278-03-48  
Вологда (8172)26-41-59  
Воронеж (473)204-51-73  
Екатеринбург (343)384-55-89

Иваново (4932)77-34-06  
Ижевск (3412)26-03-58  
Иркутск (395)279-98-46  
Казань (843)206-01-48  
Калининград (4012)72-03-81  
Калуга (4842)92-23-67  
Кемерово (3842)65-04-62  
Киров (8332)68-02-04  
Коломна (4966)23-41-49  
Кострома (4942)77-07-48  
Краснодар (861)203-40-90  
Красноярск (391)204-63-61  
Курск (4712)77-13-04  
Курган (3522)50-90-47  
Липецк (4742)52-20-81

Магнитогорск (3519)55-03-13  
Москва (495)268-04-70  
Мурманск (8152)59-64-93  
Набережные Челны (8552)20-53-41  
Нижний Новгород (831)429-08-12  
Новокузнецк (3843)20-46-81  
Ноябрьск (3496)41-32-12  
Новосибирск (383)227-86-73  
Омск (3812)21-46-40  
Орел (4862)44-53-42  
Оренбург (3532)37-68-04  
Пенза (8412)22-31-16  
Петрозаводск (8142)55-98-37  
Псков (8112)59-10-37  
Пермь (342)205-81-47

Ростов-на-Дону (863)308-18-15  
Рязань (4912)46-61-64  
Самара (846)206-03-16  
Санкт-Петербург (812)309-46-40  
Саратов (845)249-38-78  
Севастополь (8692)22-31-93  
Саранск (8342)22-96-24  
Симферополь (3652)67-13-56  
Смоленск (4812)29-41-54  
Сочи (862)225-72-31  
Ставрополь (8652)20-65-13  
Сургут (3462)77-98-35  
Сыктывкар (8212)25-95-17  
Тамбов (4752)50-40-97  
Тверь (4822)63-31-35

Тольятти (8482)63-91-07  
Томск (3822)98-41-53  
Тула (4872)33-79-87  
Тюмень (3452)66-21-18  
Ульяновск (8422)24-23-59  
Улан-Удэ (3012)59-97-51  
Уфа (347)229-48-12  
Хабаровск (4212)92-98-04  
Чебоксары (8352)28-53-07  
Челябинск (351)202-03-61  
Череповец (8202)49-02-64  
Чита (3022)38-34-83  
Якутск (4112)23-90-97  
Ярославль (4852)69-52-93

Россия +7(495)268-04-70

Казахстан +(727)345-47-04

Беларусь +(375)257-127-884

Узбекистан +998(71)205-18-59

Киргизия +996(312)96-26-47

эл.почта: [mxo@nt-rt.ru](mailto:mxo@nt-rt.ru) || сайт: <https://melform.nt-rt.ru/>